

**Paper Reference(s) 4PH1/1P 4SD0/1P  
Pearson Edexcel International GCSE (9–1)**

## **Physics**

**Science (Double Award) 4SD0**

**PAPER: 1P**

## **Diagram Booklet**

**In the boxes below, write your name, centre number and candidate number.**

<b>Surname</b>					
<b>Other names</b>					
<b>Centre Number</b>					
<b>Candidate Number</b>					

## **INSTRUCTIONS**

**There may be spare copies of some diagrams in case you need them.**

**THIS DIAGRAM BOOKLET MUST BE RETURNED WITH THE QUESTION PAPER AT THE END OF THE EXAMINATION.**

## Contents

### Page

4	Question 1(a)
5	Question 3
6	Question 4(b)
7	Question 4(b) (Spare copy)
8	Question 5(c)
9	Question 5(c) (Spare copy)
10	Question 6(b)
11	Question 6(b) (Spare copy)
12	Question 7
13	Question 9(b)
14	Question 9(b)(iii)
15	Question 9(b)(iii) (Spare copy)
16	Question 10
17	Question 10(b)
18	Question 11
19	Question 12

## Question 1(a)

Graph P

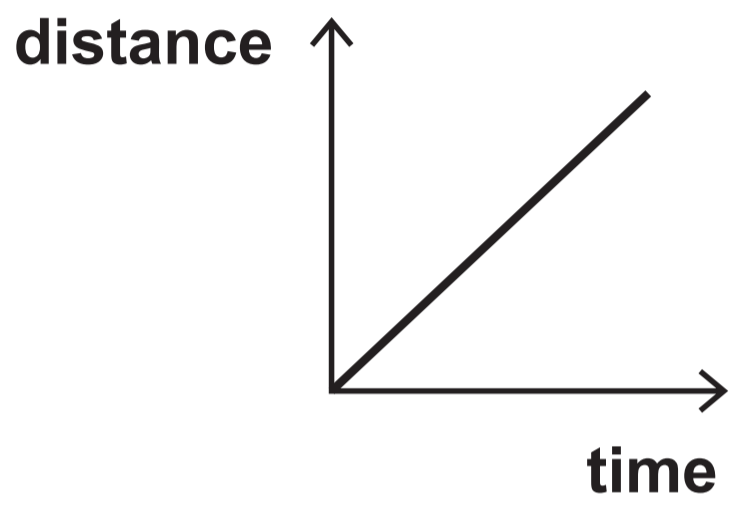

Graph Q

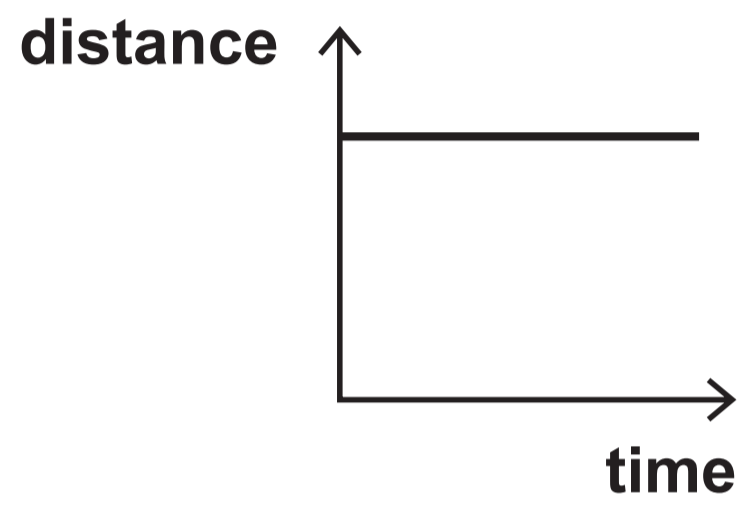

Graph R

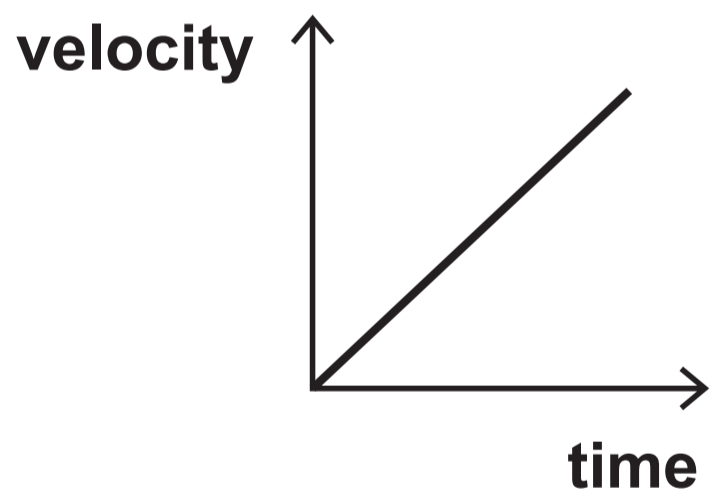

Graph S

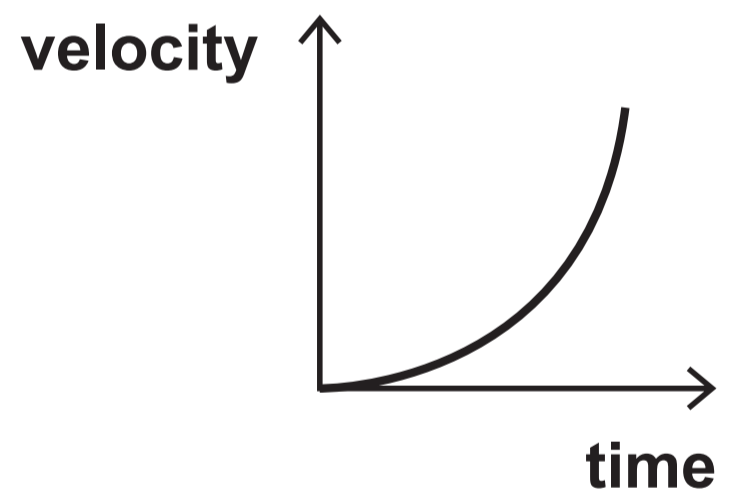

Question 3

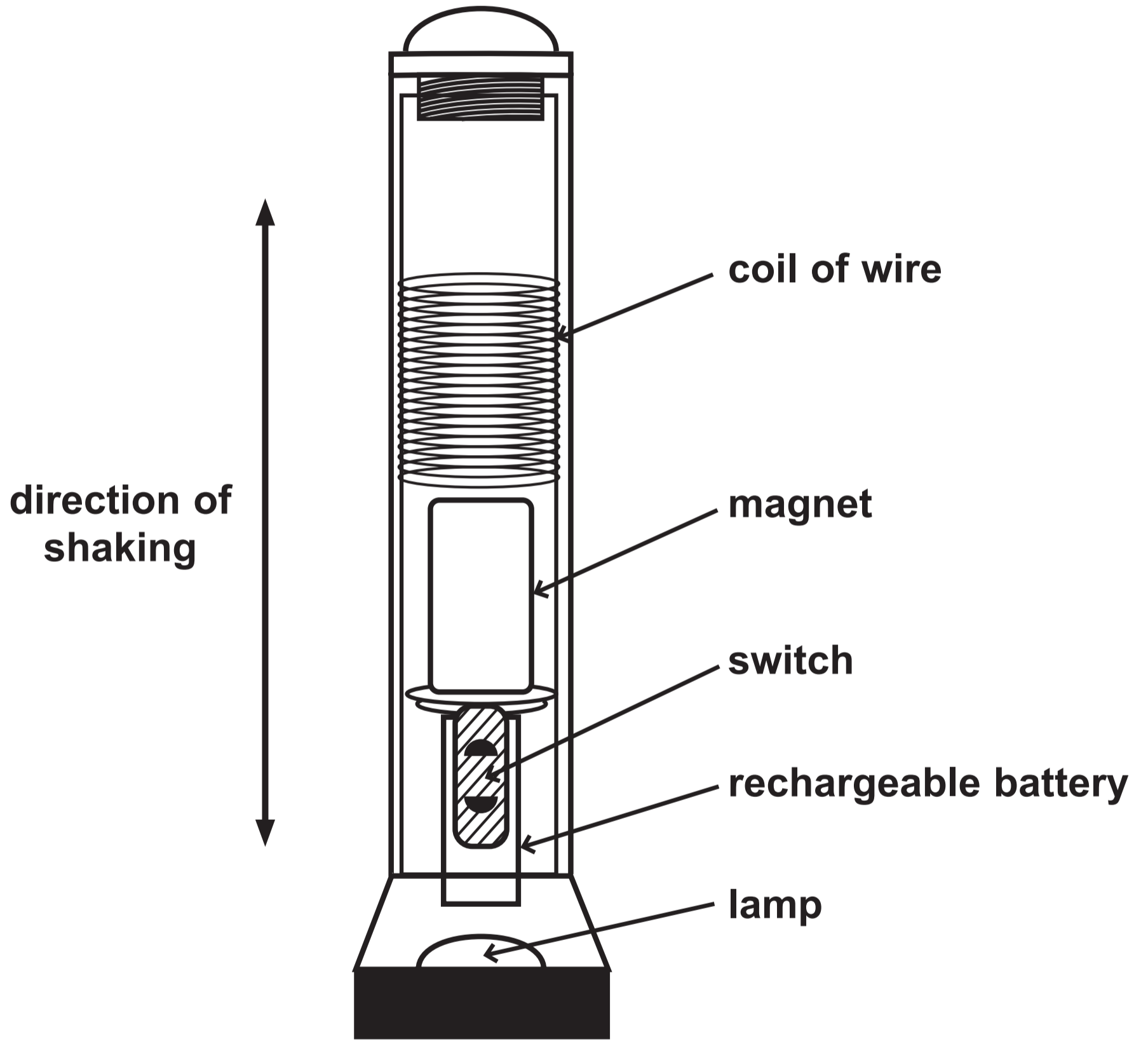

## Question 4(b)

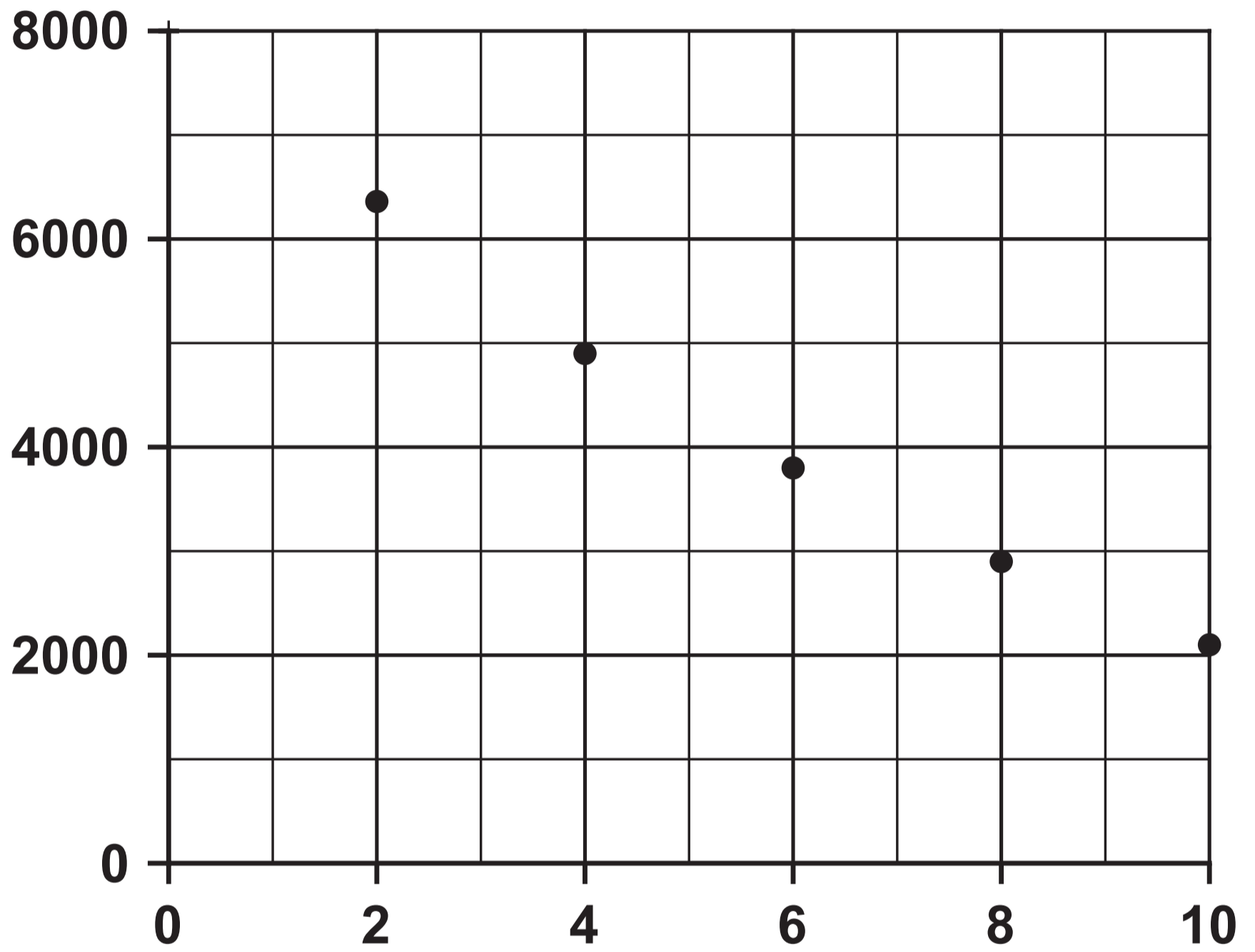

## Question 4(b)

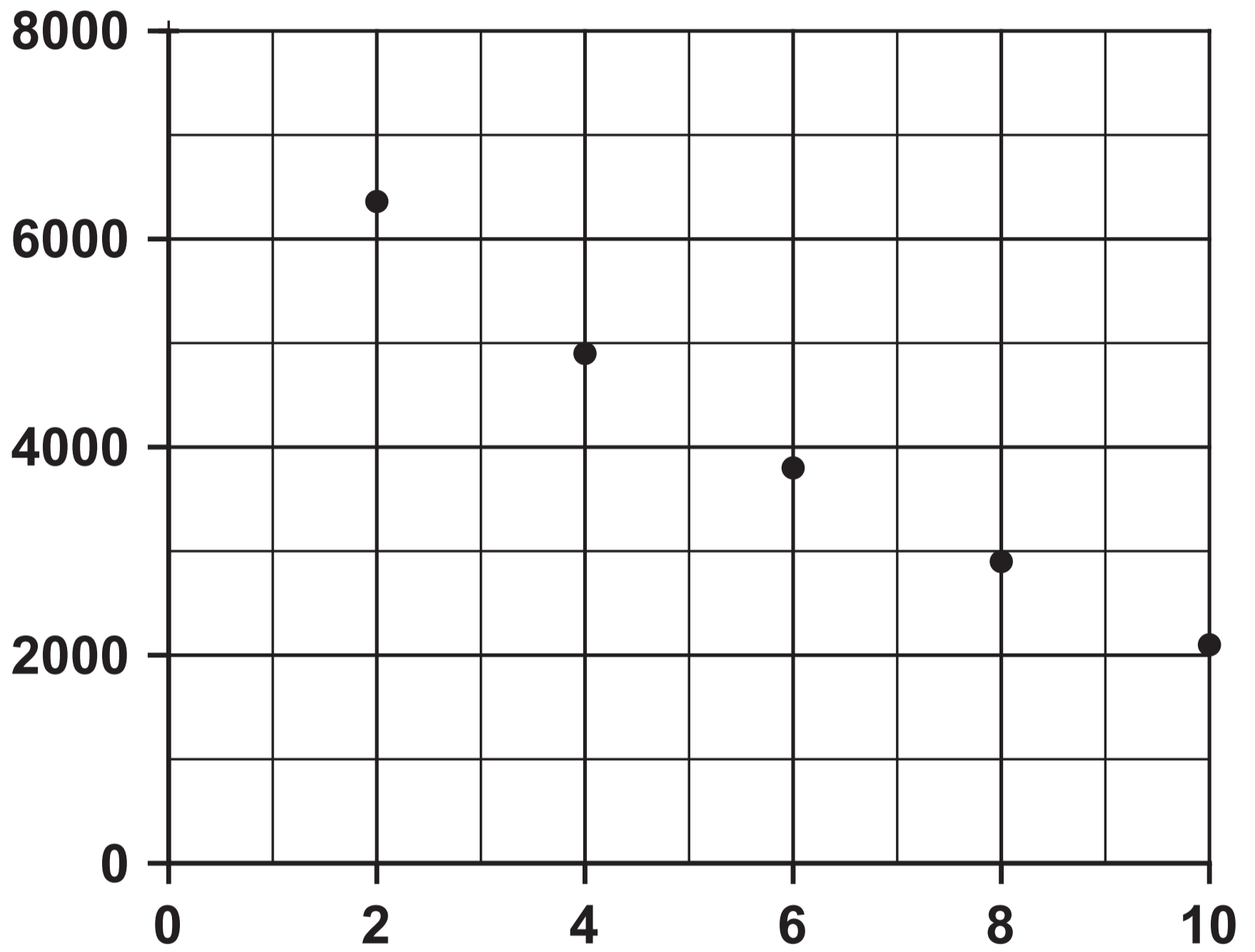

**Question 5(c)**

<b>Mass in g</b>
<b>18.96</b>
<b>19.01</b>
<b>19.05</b>
<b>18.98</b>
<b>19.34</b>
<b>19.04</b>



**Question 5(c)**

<b>Mass in g</b>
<b>18.96</b>
<b>19.01</b>
<b>19.05</b>
<b>18.98</b>
<b>19.34</b>
<b>19.04</b>

Question 6(b)

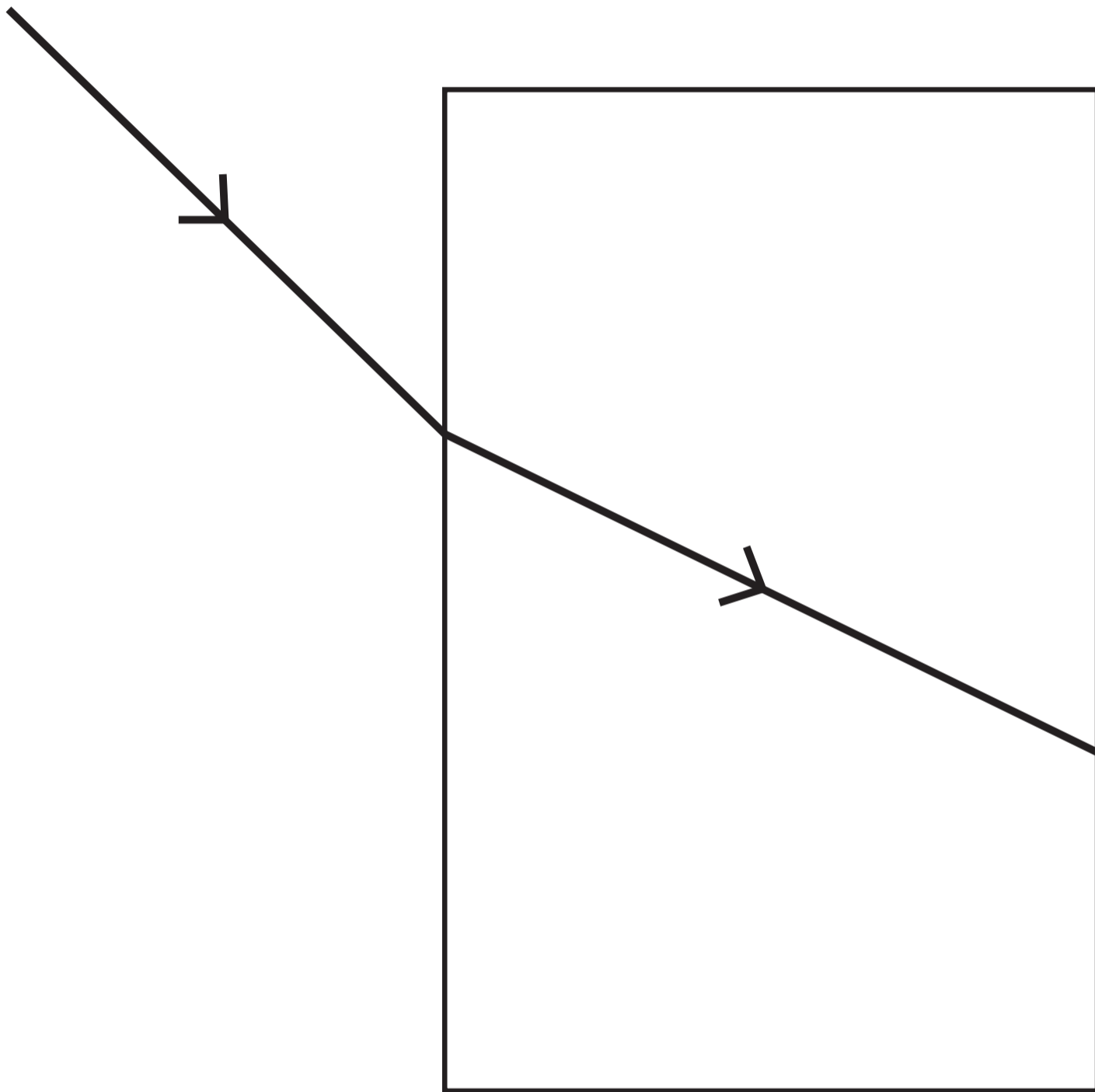

Question 6(b)

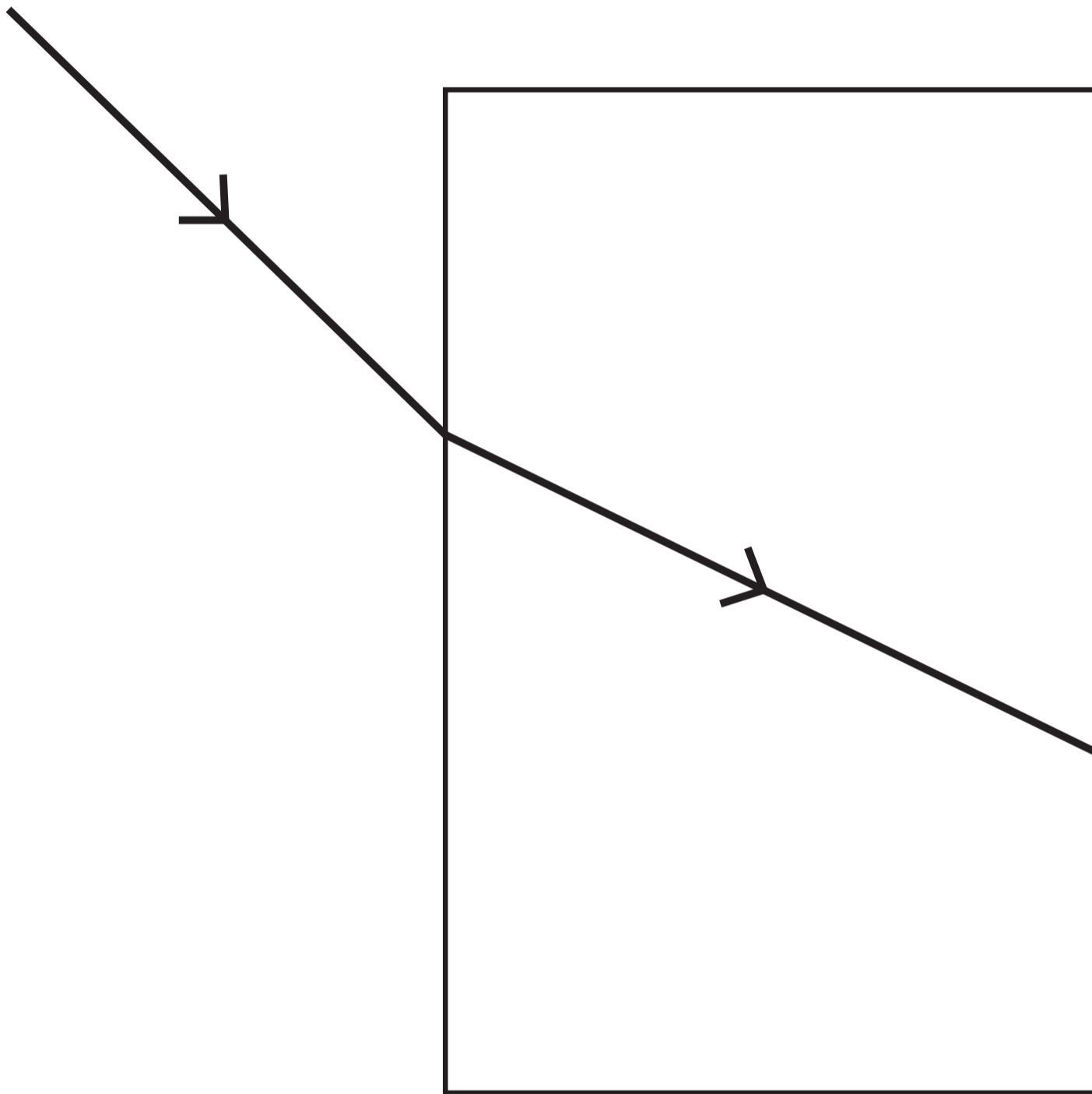

## Question 7

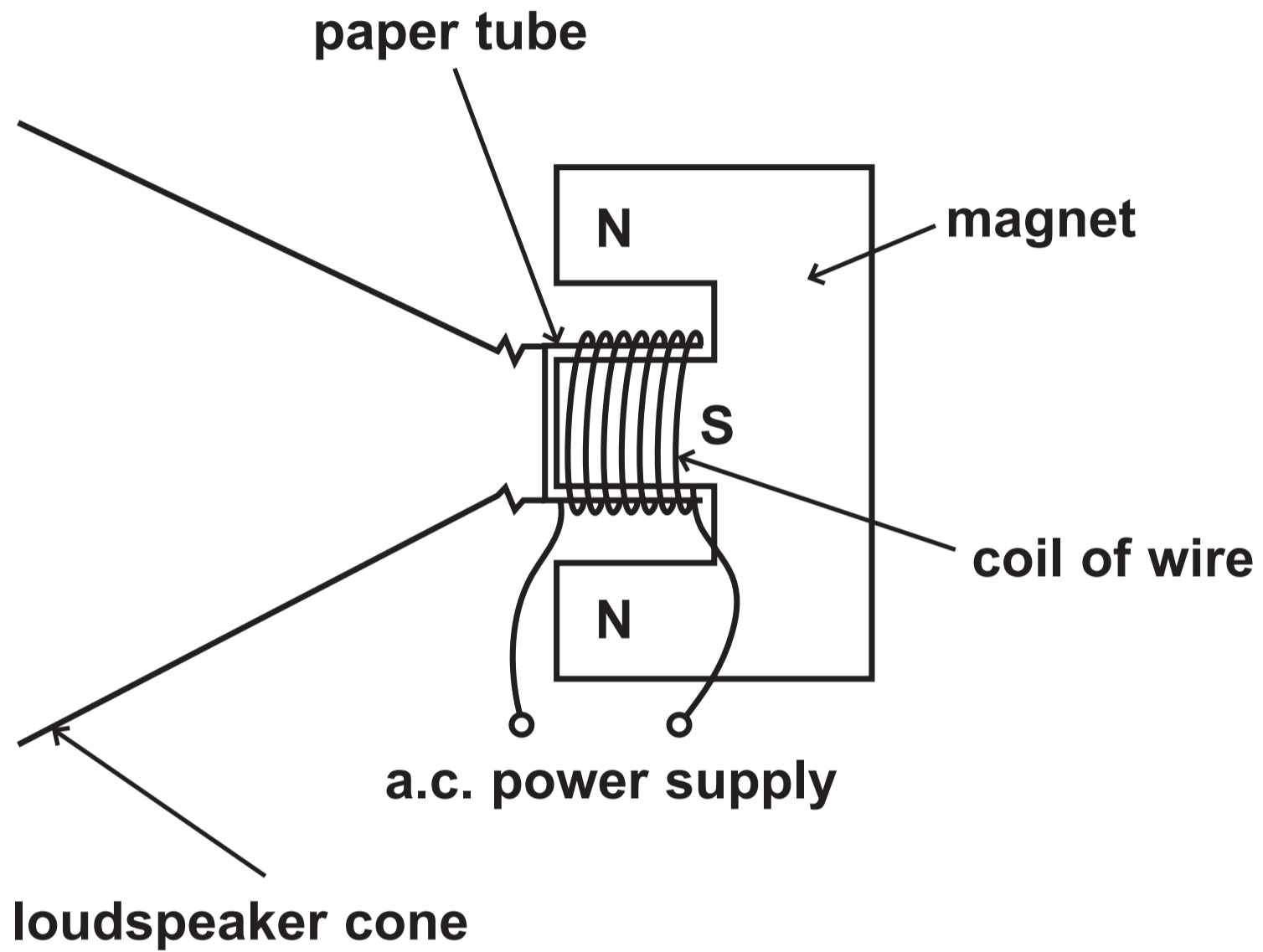

## Question 9(b)

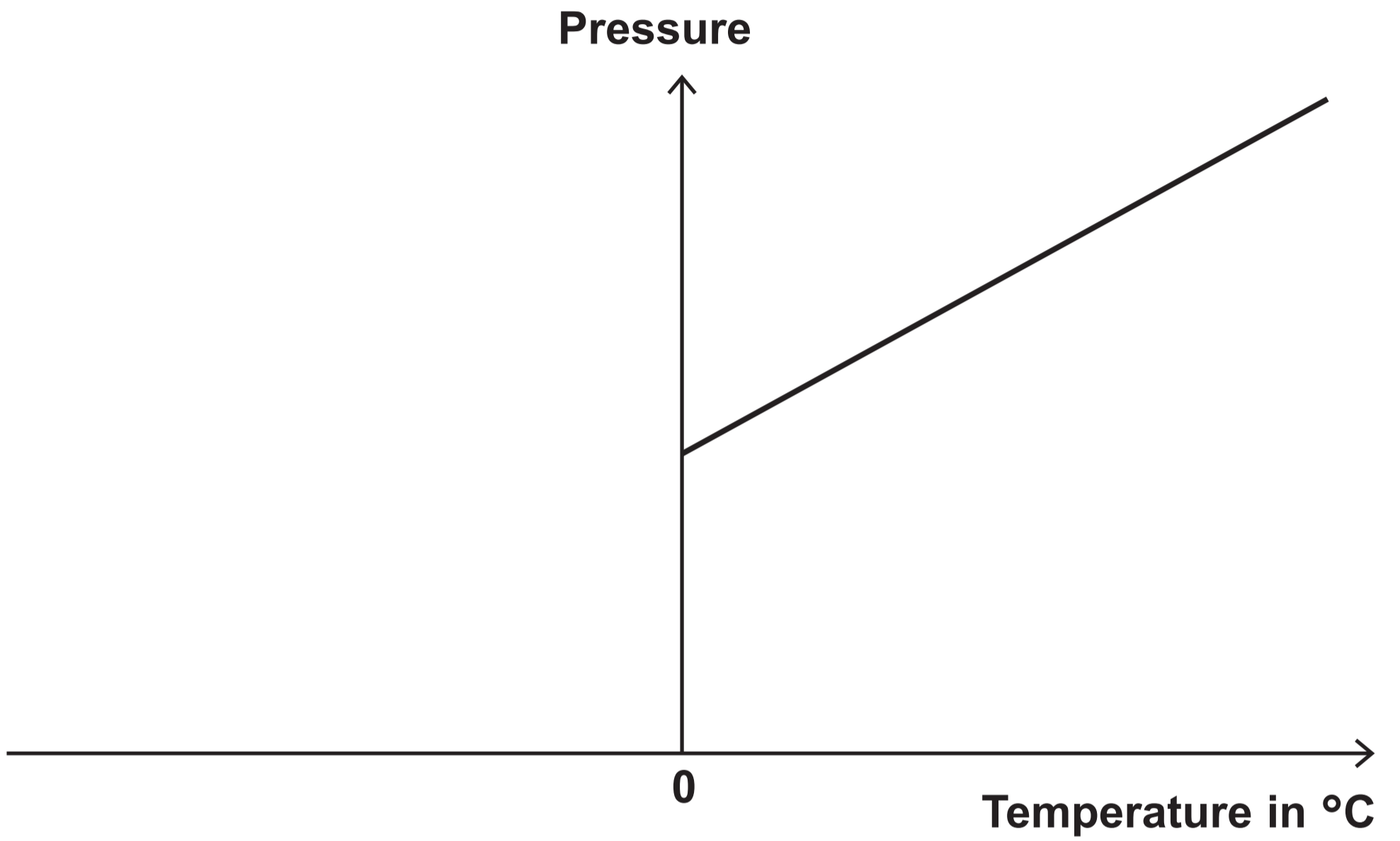

## Question 9(b)(iii)

Pressure

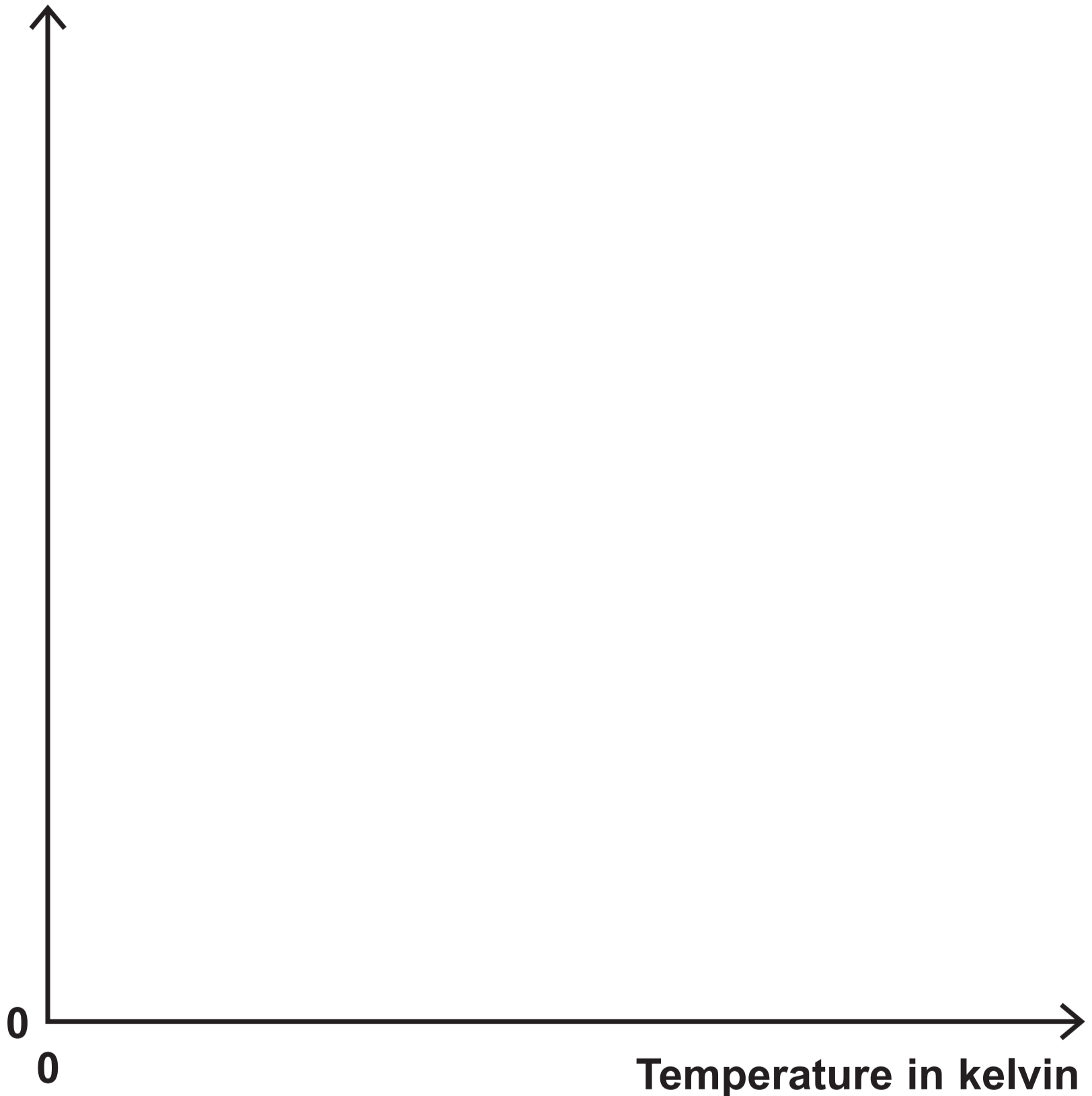

## Question 9(b)(iii)

Pressure

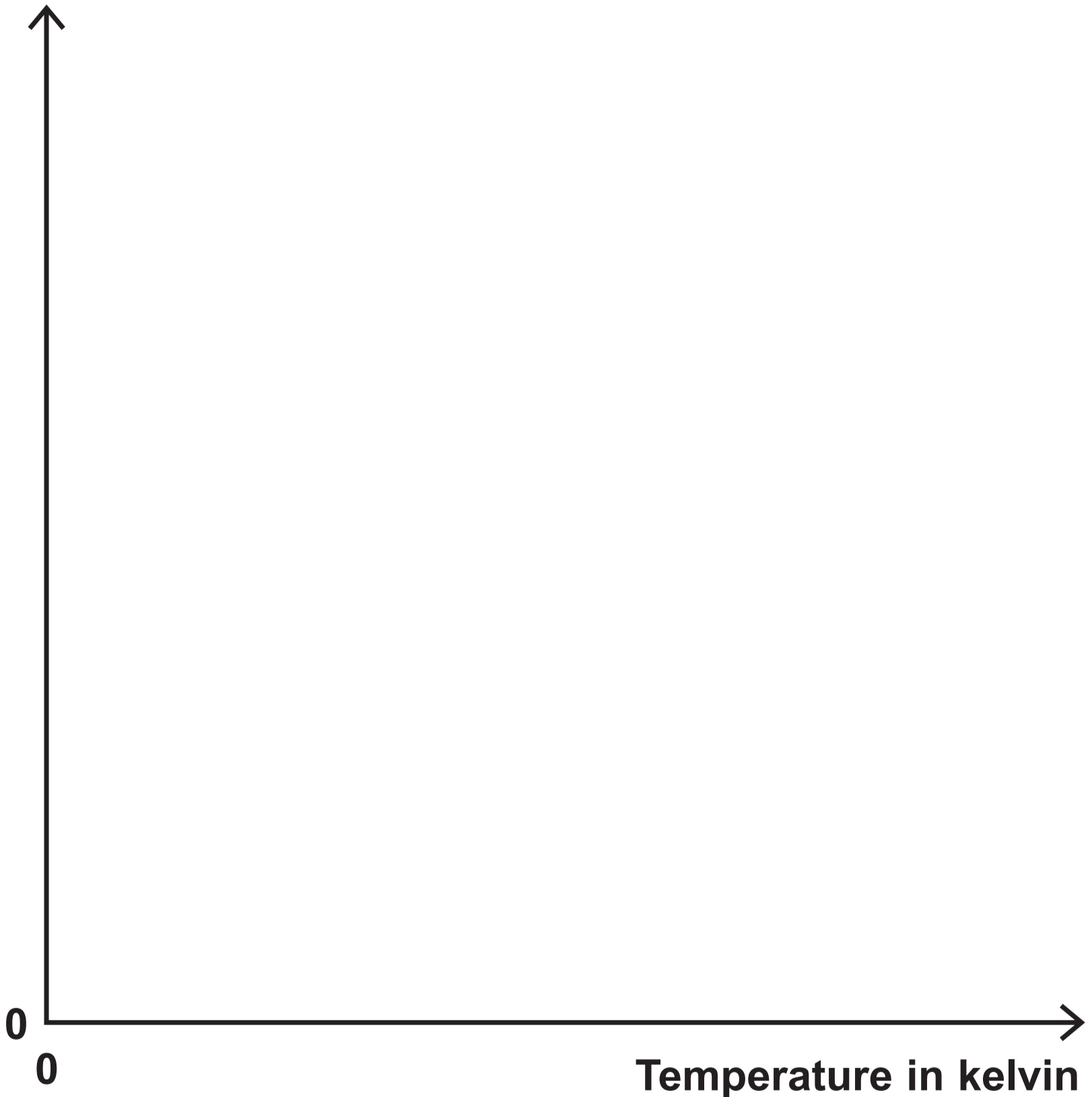

Question 10

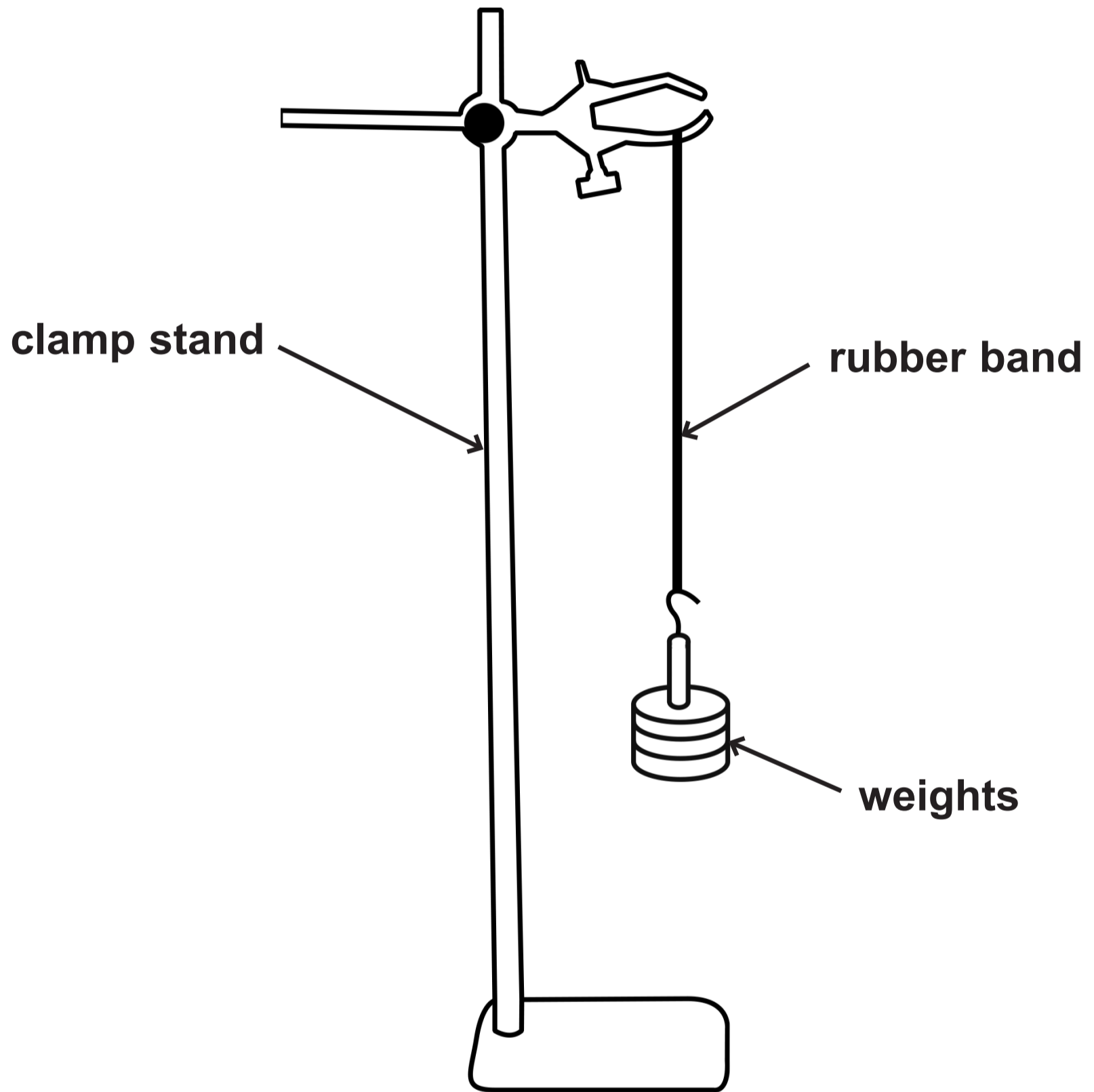



## Question 10(b)

**Weight  
in N**

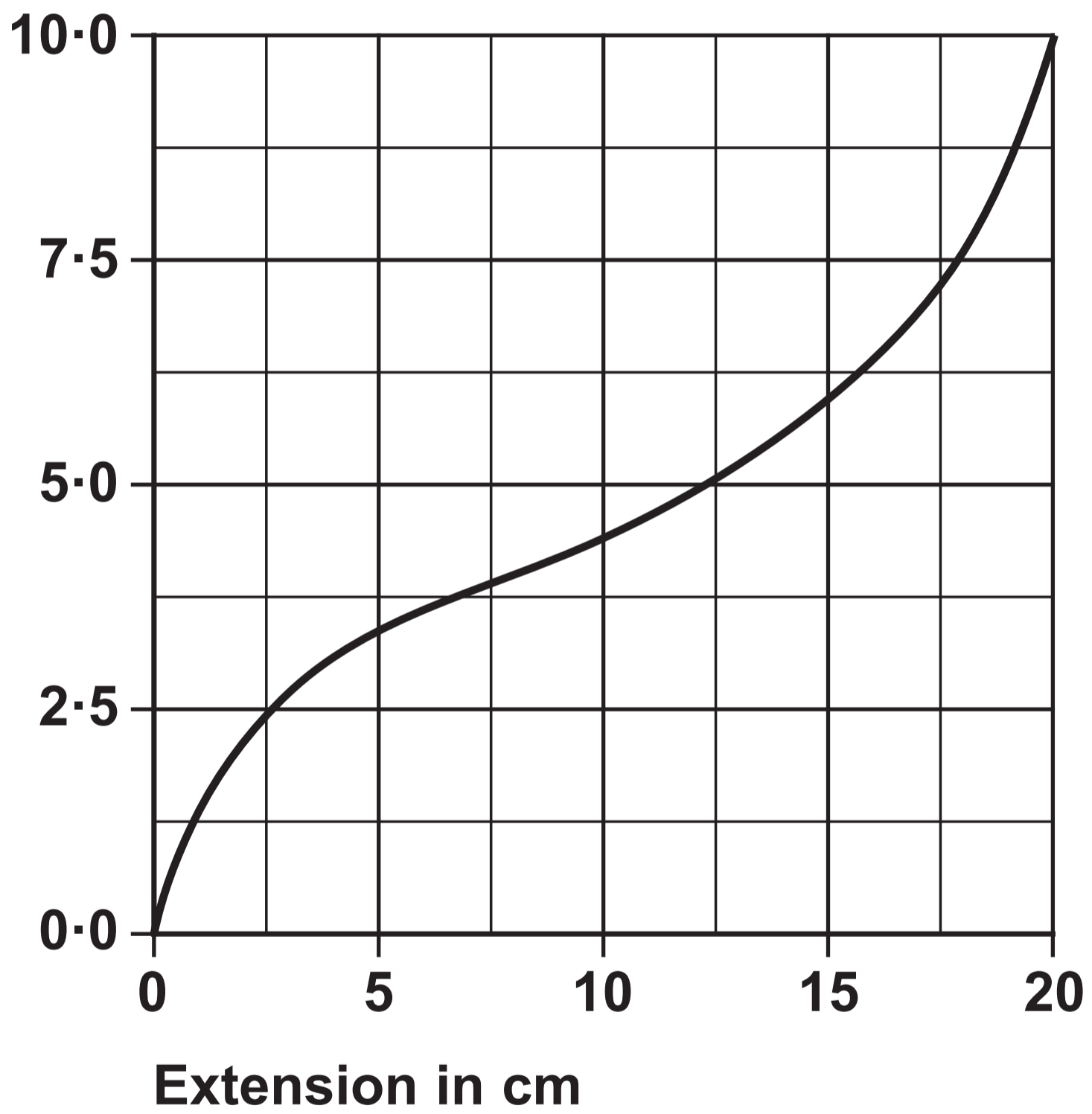

## Question 11

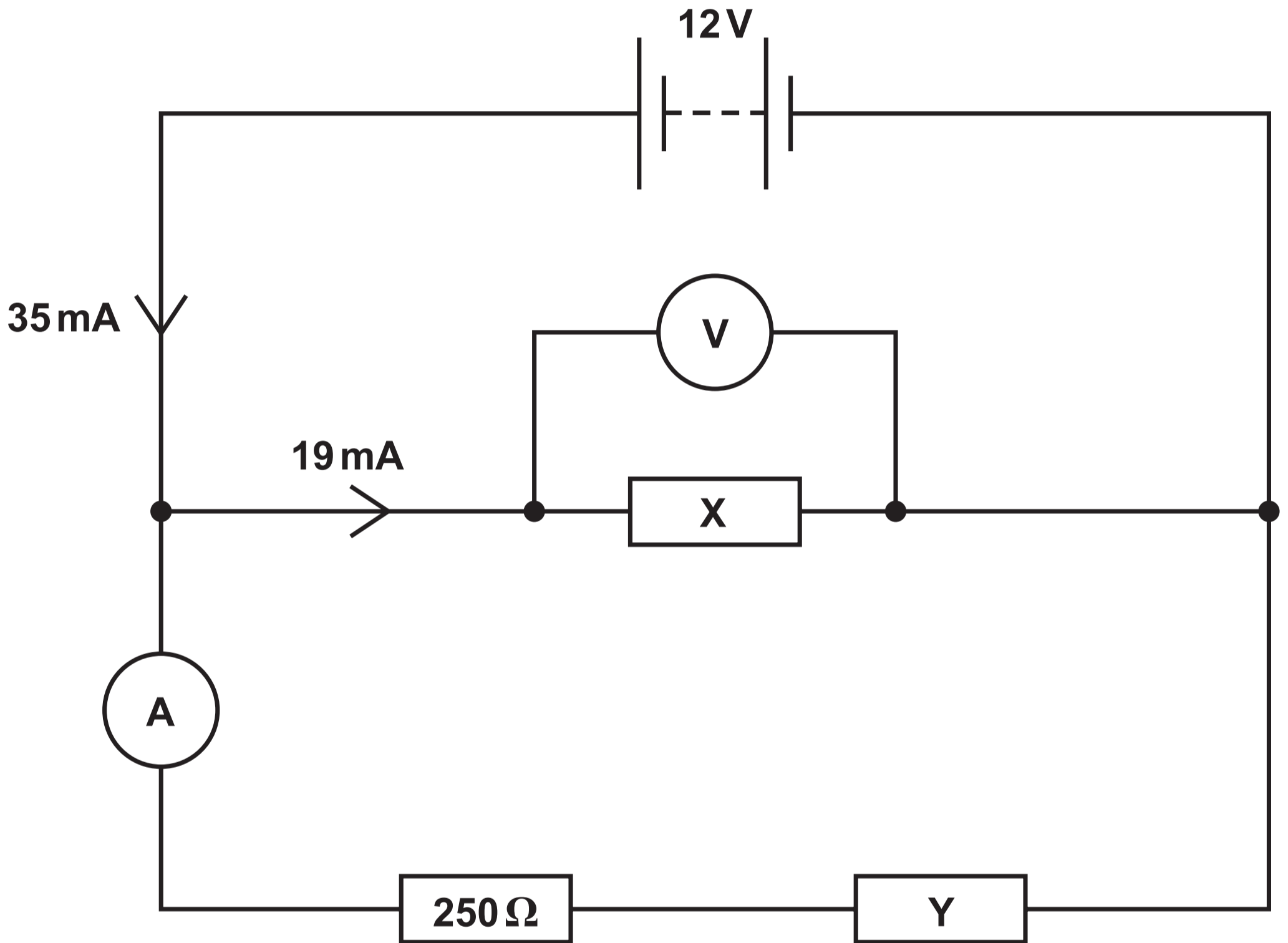

## Question 12

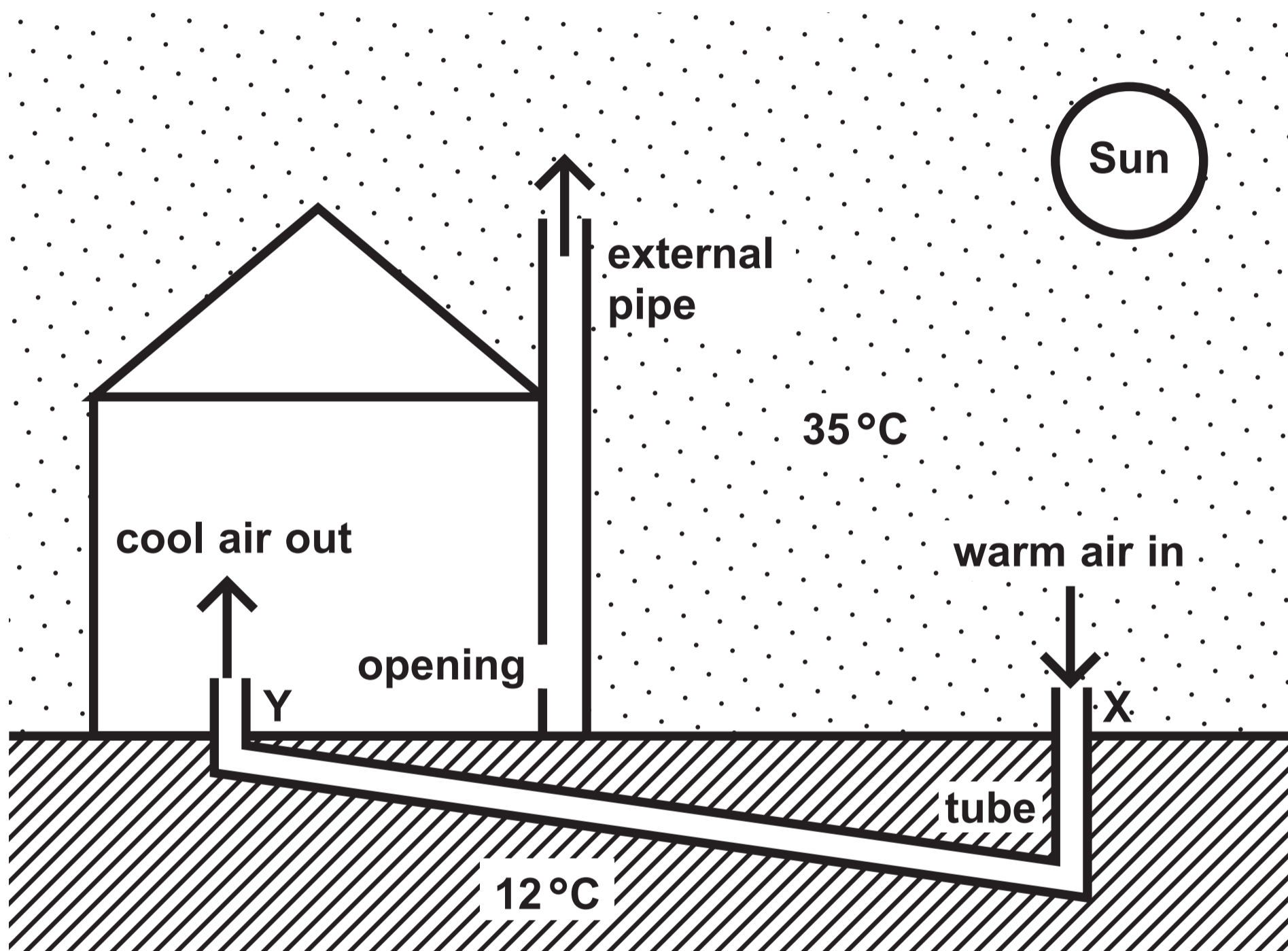

**Question 3**

**(Source: adapted from © [www.shutterstock.com/1328720216](http://www.shutterstock.com/1328720216))**